

# SOT-23 Plastic-Encapsulate MOSFETS

SI2301

## SI2301 P-Channel 20-V(D-S) MOSFET

$V_{(BR)DSS}$	$R_{DS(on)MAX}$	$I_D$
-20V	0.100Ω@-4.5V	-2.8A
	0.130 Ω@-2.5V	

### General FEATURE

- TrenchFET Power MOSFET
- Lead free product is acquired
- Surface mount package

### APPLICATION

- Load Switch for Portable Devices
- DC/DC Converter

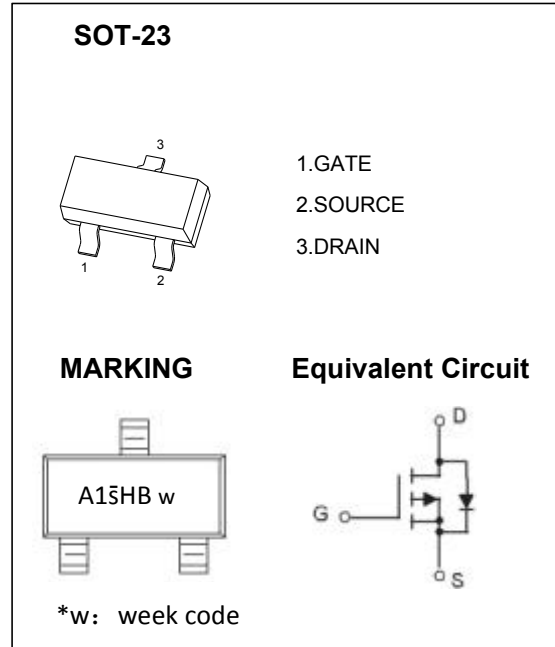

### Maximum ratings ( $T_a=25^{\circ}\text{C}$ unless otherwise noted)

Parameter	Symbol	Value	Unit
Drain-Source Voltage	$V_{DS}$	-20	V
Gate-Source Voltage	$V_{GS}$	±12	
Continuous Drain Current	$I_D$	-2.8	A
Pulsed Drain Current	$I_{DM}$	-10	
Continuous Source-Drain Diode Current	$I_S$	-1.30	
Maximum Power Dissipation	$P_D$	1.0	W
Thermal Resistance from Junction to Ambient( $t \leq 5s$ )	$R_{\theta JA}$	178	$^{\circ}\text{C/W}$
Junction Temperature	$T_J$	150	$^{\circ}\text{C}$
Storage Temperature	$T_{stg}$	-55 ~+150	

# SOT-23 Plastic-Encapsulate MOSFETS

SI2301

## MOSFET ELECTRICAL CHARACTERISTICS

T<sub>a</sub> =25 °C unless otherwise specified

Parameter	Symbol	Test Condition	Min	Typ	Max	Units
<b>Static</b>						
Drain-source breakdown voltage	V <sub>(BR)DSS</sub>	V <sub>GS</sub> = 0V, I <sub>D</sub> = -250μA	-20			V
Gate-source threshold voltage	V <sub>GS(th)</sub>	V <sub>DS</sub> = V <sub>GS</sub> , I <sub>D</sub> = -250μA	-0.5	-0.7	-1	
Gate-source leakage	I <sub>GSS</sub>	V <sub>DS</sub> = 0V, V <sub>GS</sub> = ±10V			±100	nA
Zero gate voltage drain current	I <sub>DSS</sub>	V <sub>DS</sub> = -20V, V <sub>GS</sub> = 0V			-1	μA
Drain-source on-state resistance <sup>a</sup>	R <sub>DS(on)</sub>	V <sub>GS</sub> = -4.5V, I <sub>D</sub> = -2.8A		0.090	0.100	Ω
		V <sub>GS</sub> = -2.5V, I <sub>D</sub> = -2.0A		0.110	0.130	
Forward transconductance <sup>a</sup>	g <sub>fs</sub>	V <sub>DS</sub> = -5V, I <sub>D</sub> = -2.0A	4.0	6.5		S
<b>Dynamic<sup>b</sup></b>						
Input capacitance	C <sub>iss</sub>	V <sub>DS</sub> = -10V, V <sub>GS</sub> = 0V, f = 1MHz		285		pF
Output capacitance	C <sub>oss</sub>			58		
Reverse transfer capacitance	C <sub>rss</sub>			32		
Total gate charge	Q <sub>g</sub>	V <sub>DS</sub> = -10V, V <sub>GS</sub> = -4.5V, I <sub>D</sub> = -3A		5.5	10	nC
		V <sub>DS</sub> = -10V, V <sub>GS</sub> = -2.5V, I <sub>D</sub> = -2A		2.9	6	
Gate-source charge	Q <sub>gs</sub>			0.45		
Gate-drain charge	Q <sub>gd</sub>			0.75		
Gate resistance	R <sub>g</sub>	f = 1MHz		6.0		Ω
Turn-on delay time	t <sub>d(on)</sub>	V <sub>DD</sub> = -10V, R <sub>L</sub> = 5Ω, I <sub>D</sub> = -1A, V <sub>GEN</sub> = -4.5V, R <sub>g</sub> = 3Ω		9.8	20	ns
Rise time	t <sub>r</sub>			4.9	60	
Turn-off delay time	t <sub>d(off)</sub>			20.5	50	
Fall time	t <sub>f</sub>			7.0	20	
<b>Drain-source body diode characteristics</b>						
Continuous source-drain diode current	I <sub>S</sub>	T <sub>C</sub> = 25°C			-1.3	A
Pulse diode forward current <sup>a</sup>	I <sub>SM</sub>				-10	
Body diode voltage	V <sub>SD</sub>	I <sub>S</sub> = -1.0A		-0.8	-1.2	V

**Notes :**

a. Pulse Test : Pulse Width < 300μs, Duty Cycle ≤2%.

b. Guaranteed by design not subject to production testing.

# SOT-23 Plastic-Encapsulate MOSFETS

SI2301

## Typical Electrical and Thermal Characteristics

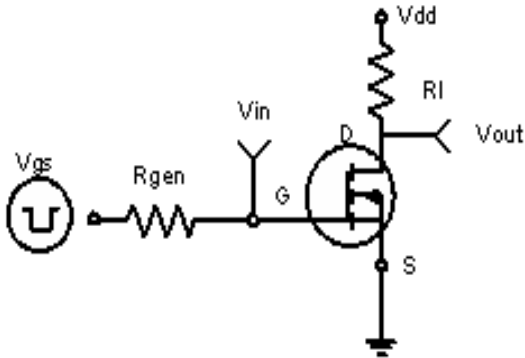

Figure 1: Switching Test Circuit

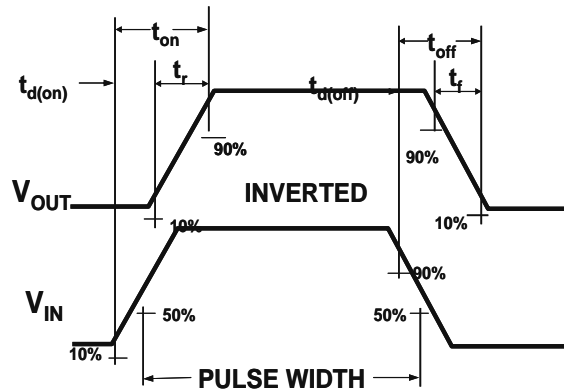

Figure 2: Switching Waveforms

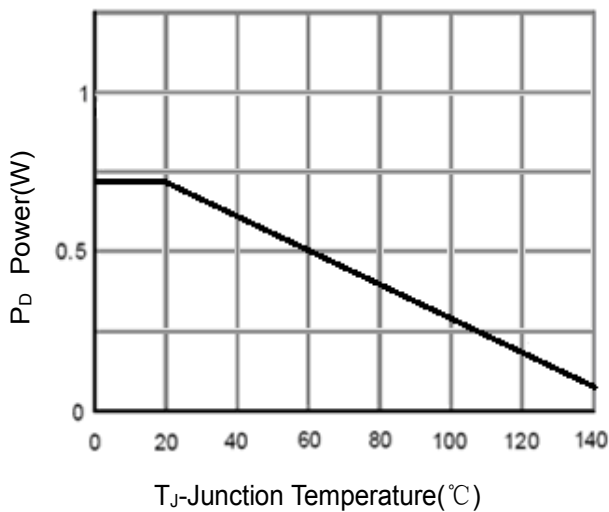

Figure 3 Power Dissipation

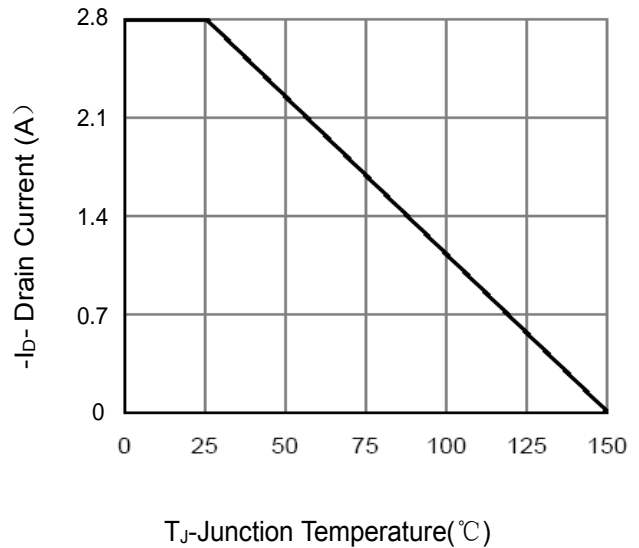

Figure 4 Drain Current

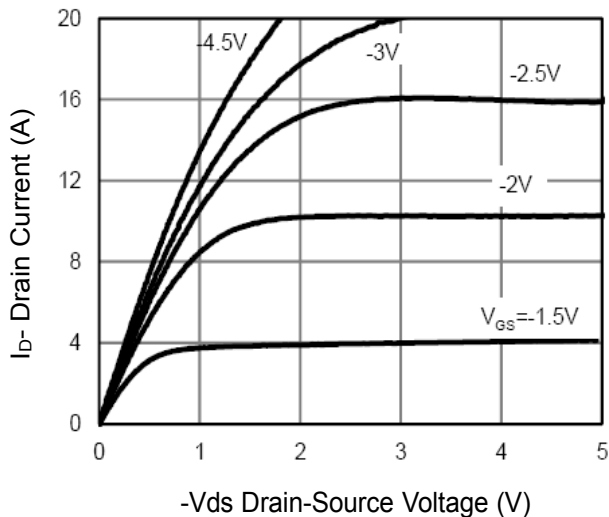

Figure 5 Output Characteristics

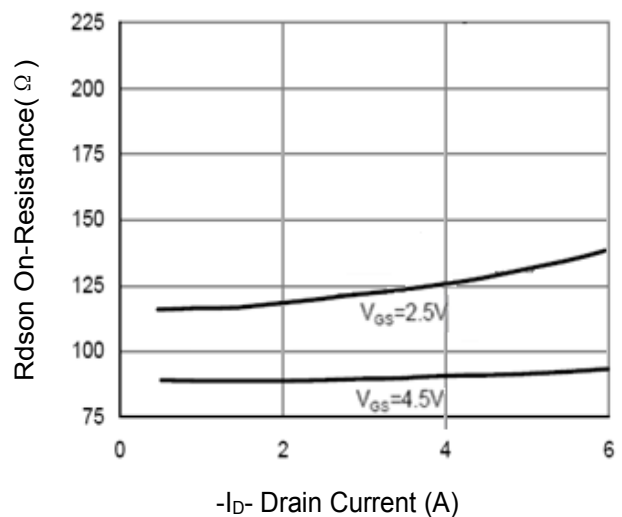

Figure 6 Drain-Source On-Resistance

# SOT-23 Plastic-Encapsulate MOSFETS

SI2301

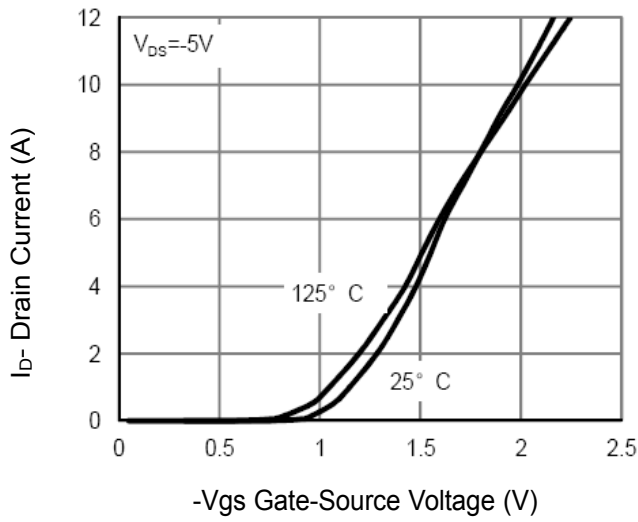

Figure 7 Transfer Characteristics

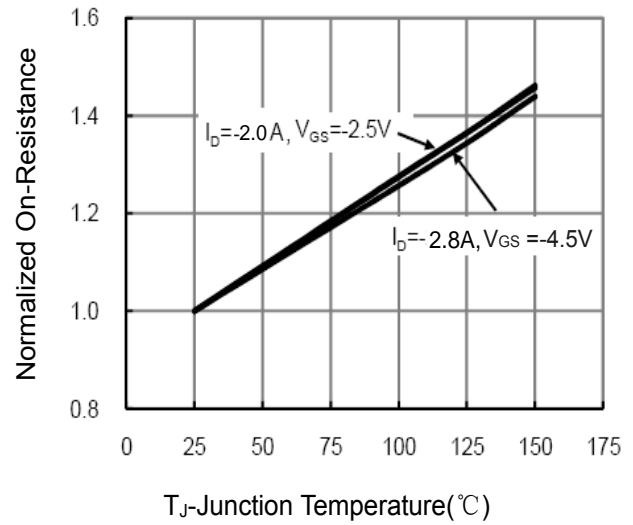

Figure 8 Drain-Source On-Resistance

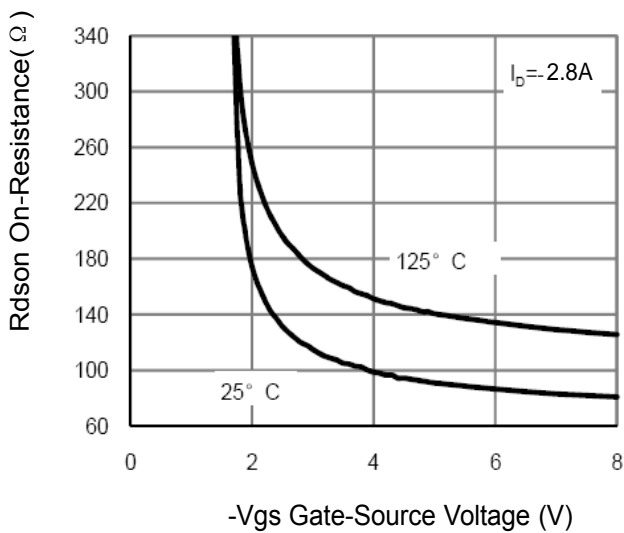

Figure 9 Rds(on) vs Vgs

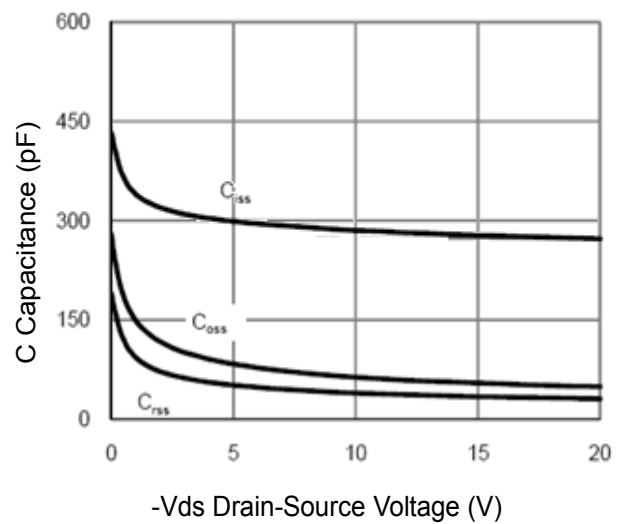

Figure 10 Capacitance vs Vds

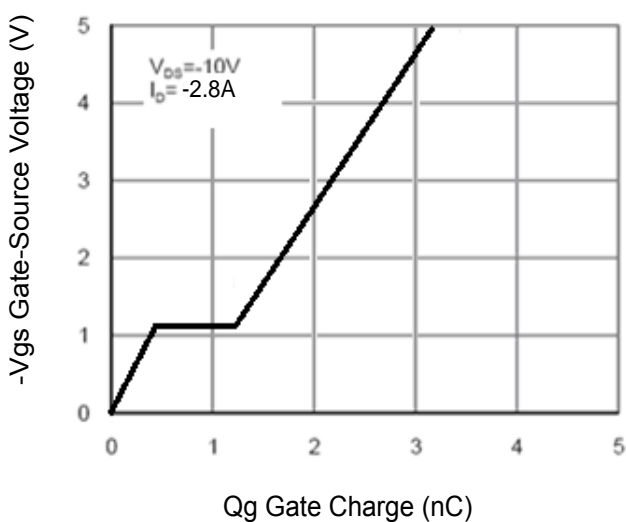

Figure 11 Gate Charge

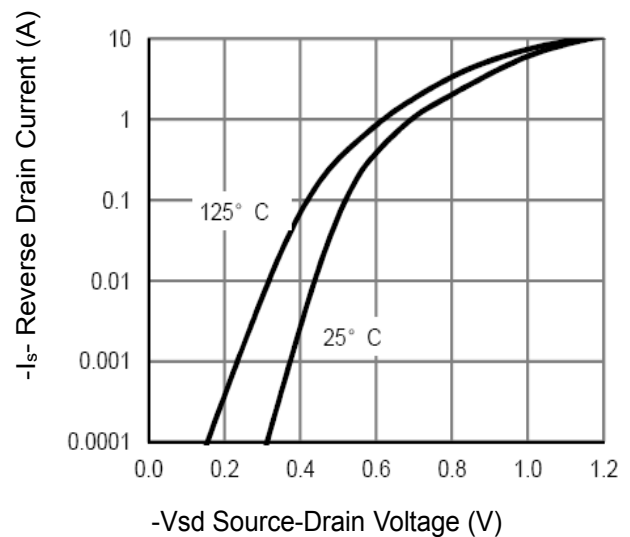

Figure 12 Source- Drain Diode Forward

# SOT-23 Plastic-Encapsulate MOSFETS

SI2301

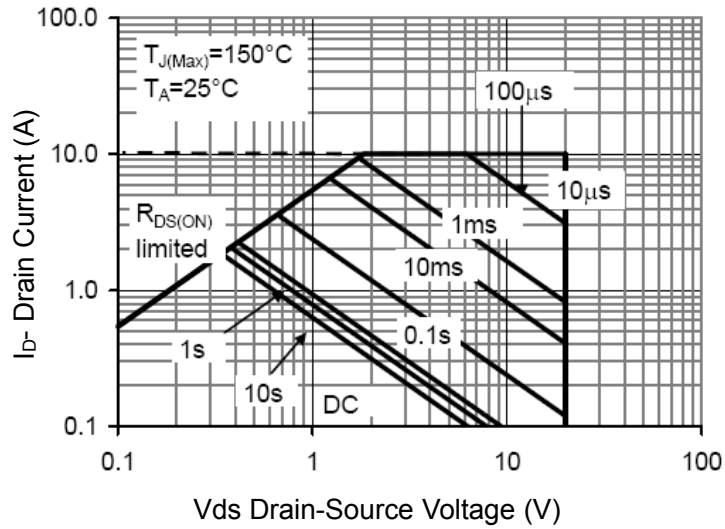

Figure 13 Safe Operation Area

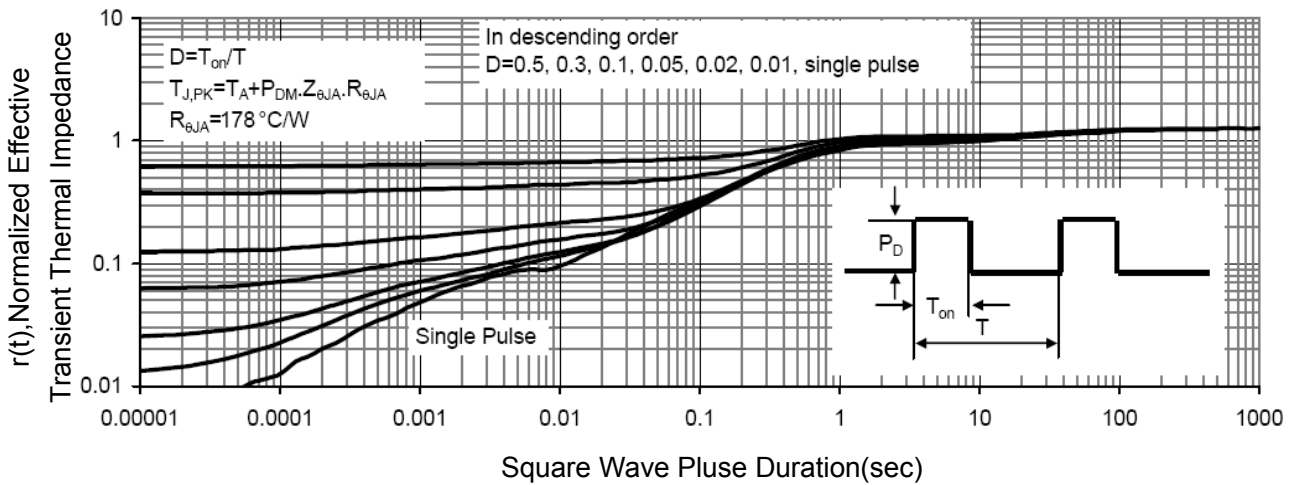
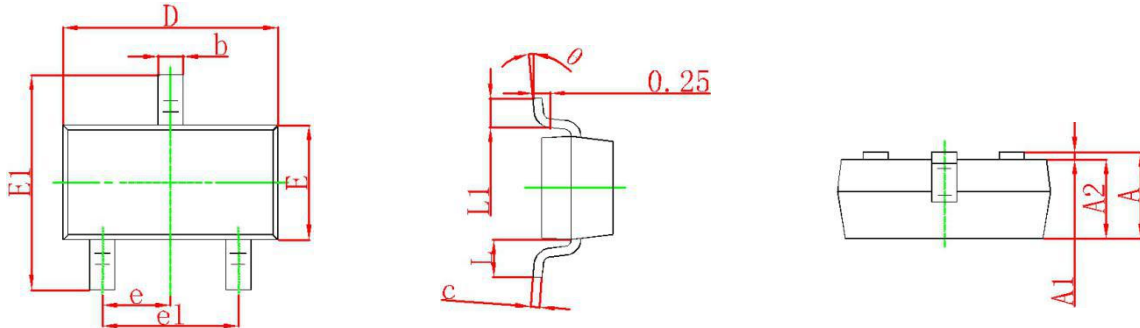

Figure 14 Normalized Maximum Transient Thermal Impedance

# SOT-23 Plastic-Encapsulate MOSFETS

SI2301

## SOT-23 Package Outline Dimensions



Symbol	Dimensions In Millimeters		Dimensions In Inches	
	Min	Max	Min	Max
A	0.900	1.150	0.035	0.045
A1	0.000	0.100	0.000	0.004
A2	0.900	1.050	0.035	0.041
b	0.300	0.500	0.012	0.020
c	0.080	0.150	0.003	0.006
D	2.800	3.000	0.110	0.118
E	1.200	1.400	0.047	0.055
E1	2.250	2.550	0.089	0.100
e	0.950 TYP		0.037 TYP	
e1	1.800	2.000	0.071	0.079
L	0.550 REF		0.022 REF	
L1	0.300	0.500	0.012	0.020
$\theta$	0°	8°	0°	8°

## SOT-23 Suggested Pad Layout

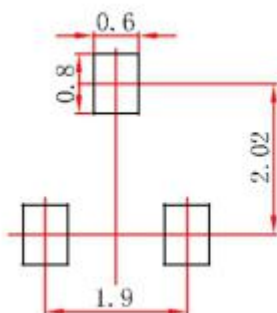

**Note:**

1. Controlling dimension: in millimeters.
2. General tolerance:  $\pm 0.05\text{mm}$ .
3. The pad layout is for reference purposes only.