

SOT-23 Plastic-Encapsulate MOSFETS

TF2302G

TF2302G N-Channel 20-V(D-S) MOSFET

$V_{(BR)DSS}$	$R_{DS(on)MAX}$	I_D
20V	0.050Ω@4.5V	3A
	0.065Ω@2.5V	

General FEATURE

- TrenchFET Power MOSFET
- Lead free product is acquired
- Surface mount package

APPLICATION

- Load Switch for Portable Devices
- DC/DC Converter

SOT-23

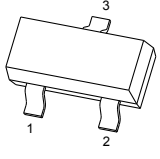

1.GATE
2.SOURCE
3.DRAIN

MARKING

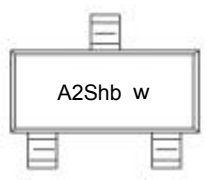

A2Shb w

*w: week code

Equivalent Circuit

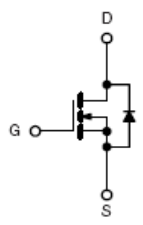

Maximum ratings ($T_a=25^{\circ}C$ unless otherwise noted)

Parameter	Symbol	Value	Unit
Drain-Source Voltage	V_{DS}	20	V
Gate-Source Voltage	V_{GS}	±10	
Continuous Drain Current	I_D	3.0	A
Pulsed Drain Current*1	I_{DM}	10	
Continuous Source-Drain Diode Current	I_S	1.0	
Maximum Power Dissipation	P_D	1.0	W
Thermal Resistance from Junction to Ambient($t \leq 5s$)	$R_{\theta JA}$	156	$^{\circ}C/W$
Junction Temperature	T_J	150	$^{\circ}C$
Storage Temperature	T_{stg}	-55 ~+150	

Note :

*1. Pulse Width $\leq 300\mu s$, Duty cycle $\leq 2\%$

SOT-23 Plastic-Encapsulate MOSFETS

TF2302G

MOSFET ELECTRICAL CHARACTERISTICS

T_a =25 °C unless otherwise specified

Parameter	Symbol	Test Condition	Min	Typ	Max	Units	
Static							
Drain-source breakdown voltage	V _{(BR)DSS}	V _{GS} = 0V, I _D = -250μA	20			V	
Gate-source threshold voltage	V _{GS(th)}	V _{DS} = V _{GS} , I _D = -250μA	0.5	0.8	1.0		
Gate-source leakage	I _{GSS}	V _{DS} = 0V, V _{GS} = ±10V			±100	nA	
Zero gate voltage drain current	I _{DSS}	V _{DS} = 16V, V _{GS} = 0V			1	μA	
Drain-source on-state resistance ^a	R _{DS(on)}	V _{GS} = 4.5V, I _D = 3A		0.045	0.055	Ω	
		V _{GS} = 2.5V, I _D = 2A		0.050	0.055		
Forward transconductance ^a	g _{fs}	V _{DS} = 5V, I _D = 3A		8.0	-	S	
Dynamic^b							
Input capacitance	C _{iss}	V _{DS} = 10V, V _{GS} = 0V, f = 1MHz		300		pF	
Output capacitance	C _{oss}				120		
Reverse transfer capacitance	C _{rss}				80		
Total gate charge	Q _g	V _{DS} = 10V, V _{GS} = 4.5V, I _D = 3A		4.0		nC	
Gate-source charge	Q _{gs}				0.65		
Gate-drain charge	Q _{gd}				1.6		
Turn-on delay time	t _{d(on)}	V _{DD} = 10V, I _D = 3A V _{GEN} = 4.5V, R _g = 6Ω		15.0		ns	
Rise time	t _r				85.0		
Turn-off delay time	t _{d(off)}				45.0		
Fall time	t _f				20.0		
Drain-source body diode characteristics							
Continuous source-drain diode current	I _S	T _C = 25°C			1.0	A	
Body diode voltage	V _{SD}	I _S = 1.0A		0.7	1.3	V	

Notes :

- a. Pulse Test : Pulse Width < 300μs, Duty Cycle ≤ 2%.
- b. Guaranteed by design, not subject to production testing.

SOT-23 Plastic-Encapsulate MOSFETS

TF2302G

Typical Electrical and Thermal Characteristics

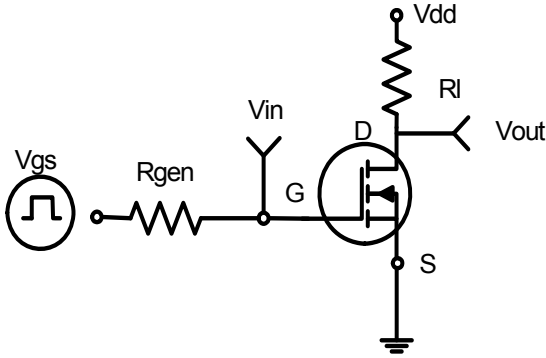

Figure 1: Switching Test Circuit

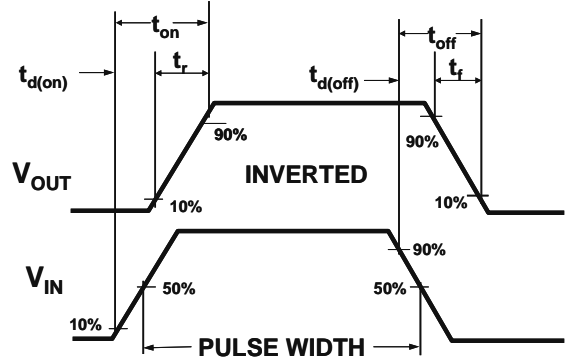

Figure 2: Switching Waveforms

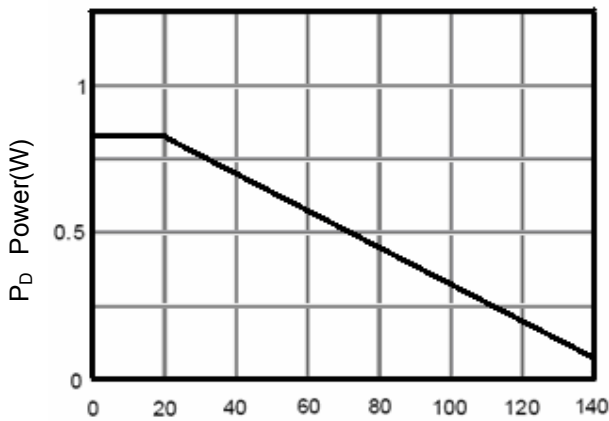

Figure 3 Power Dissipation

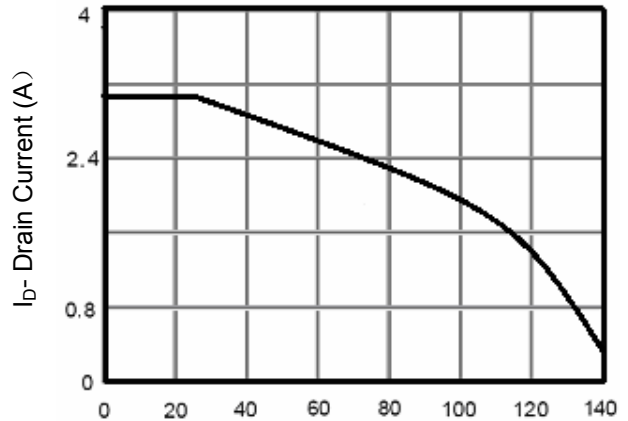

Figure 4 Drain Current

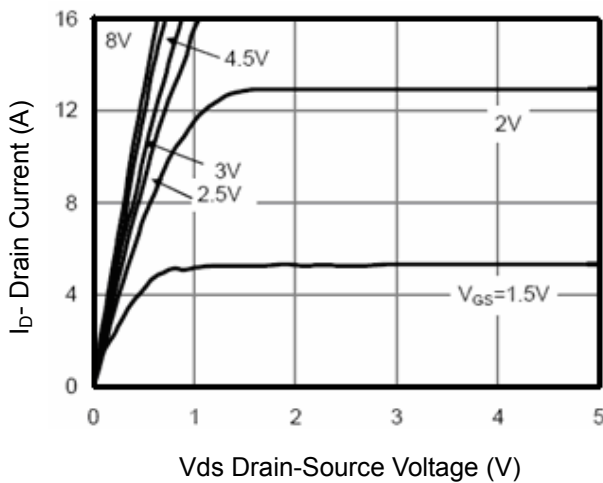

Figure 5 Output Characteristics

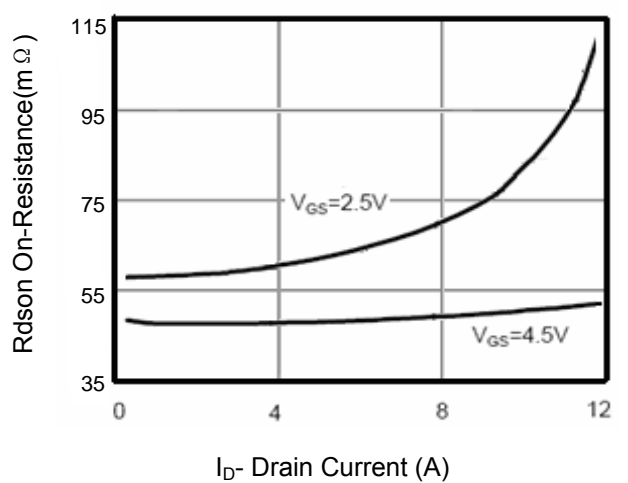

Figure 6 Drain-Source On-Resistance

SOT-23 Plastic-Encapsulate MOSFETS

TF2302G

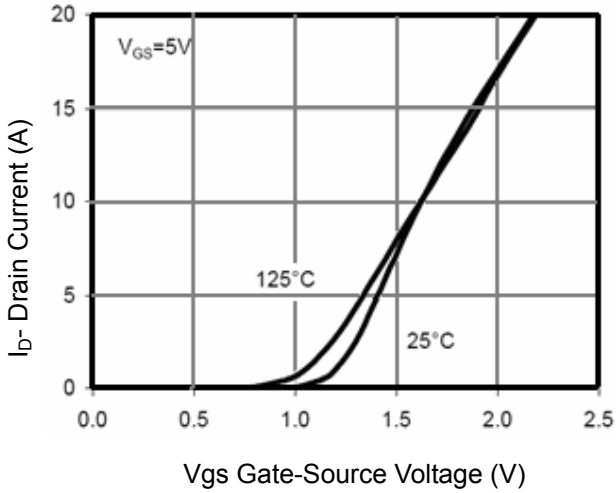

Figure 7 Transfer Characteristics

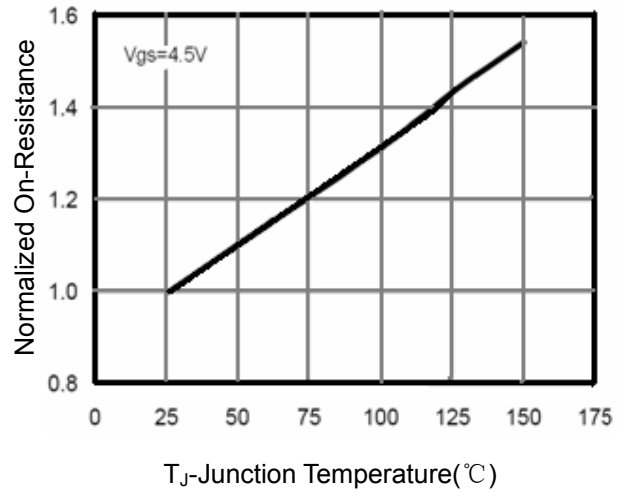

Figure 8 Drain-Source On-Resistance

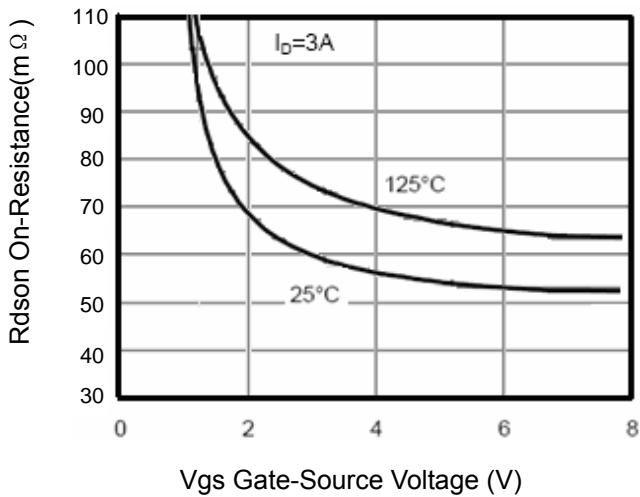

Figure 9 Rdson vs Vgs

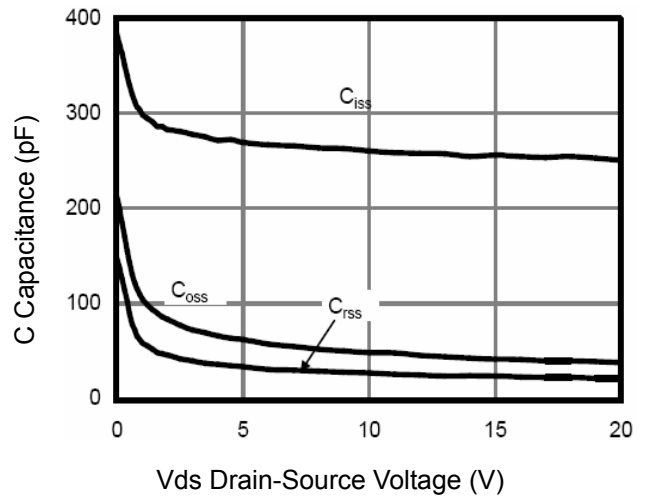

Figure 10 Capacitance vs Vds

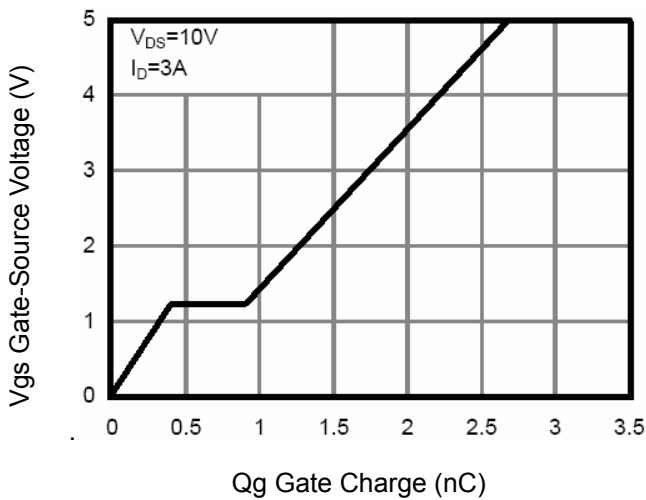

Figure 11 Gate Charge

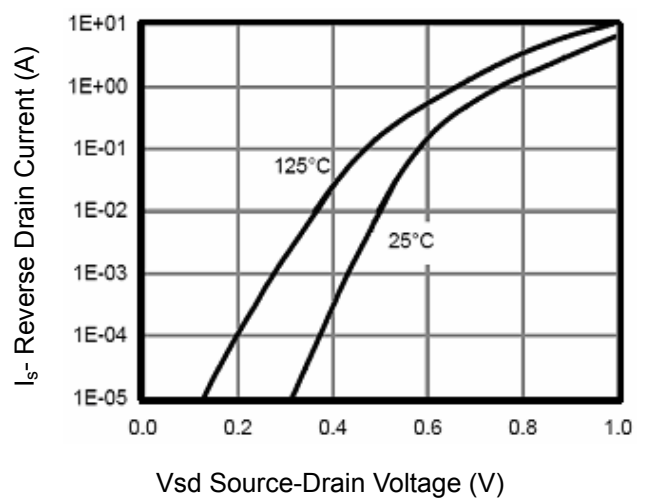

Figure 12 Source- Drain Diode Forward

SOT-23 Plastic-Encapsulate MOSFETS

TF2302G

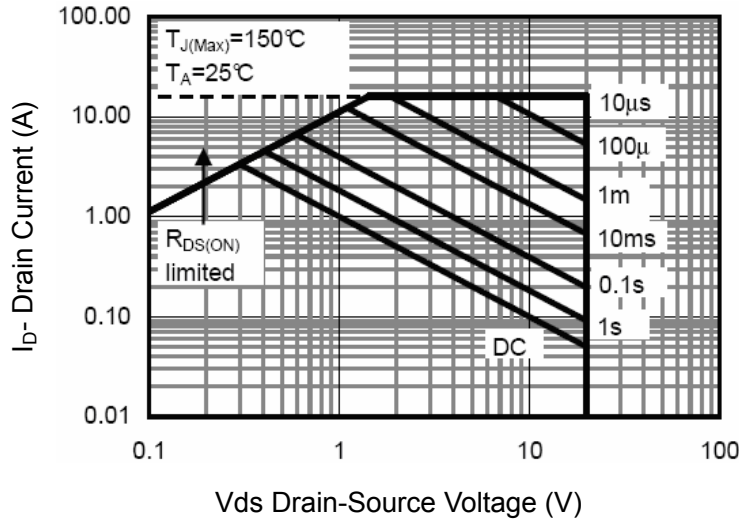

Figure 13 Safe Operation Area

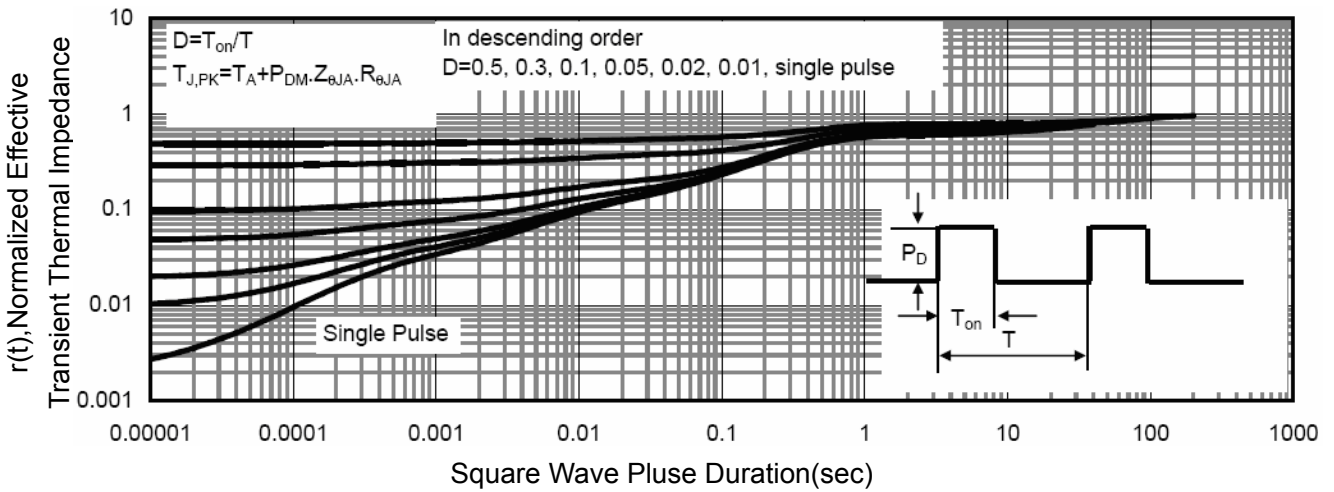
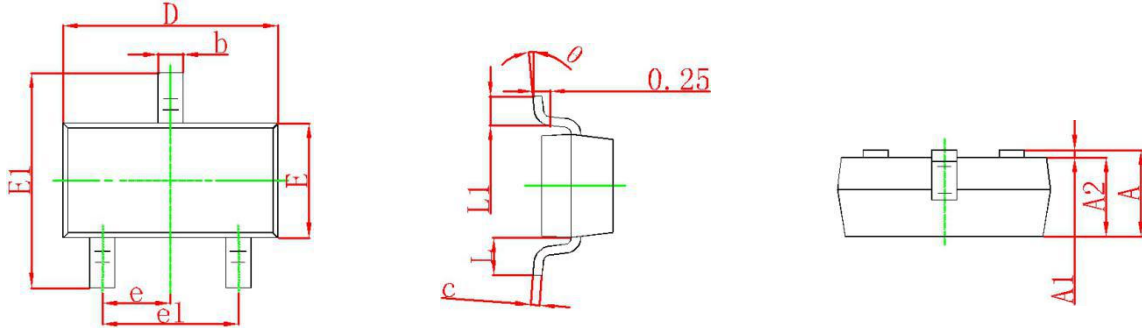

Figure 14 Normalized Maximum Transient Thermal Impedance

SOT-23 Plastic-Encapsulate MOSFETS

TF2302G

SOT-23 Package Outline Dimensions



Symbol	Dimensions In Millimeters		Dimensions In Inches	
	Min	Max	Min	Max
A	0.900	1.150	0.035	0.045
A1	0.000	0.100	0.000	0.004
A2	0.900	1.050	0.035	0.041
b	0.300	0.500	0.012	0.020
c	0.080	0.150	0.003	0.006
D	2.800	3.000	0.110	0.118
E	1.200	1.400	0.047	0.055
E1	2.250	2.550	0.089	0.100
e	0.950 TYP		0.037 TYP	
e1	1.800	2.000	0.071	0.079
L	0.550 REF		0.022 REF	
L1	0.300	0.500	0.012	0.020
θ	0°	8°	0°	8°

SOT-23 Suggested Pad Layout

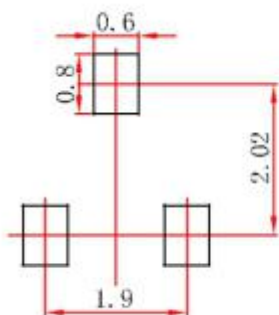

Note:

1. Controlling dimension: in millimeters.
2. General tolerance: $\pm 0.05\text{mm}$.
3. The pad layout is for reference purposes only.